

C: More than 10mm can be used
 A,B,C,D: Available in 2" to 4"
 (50~100mm)

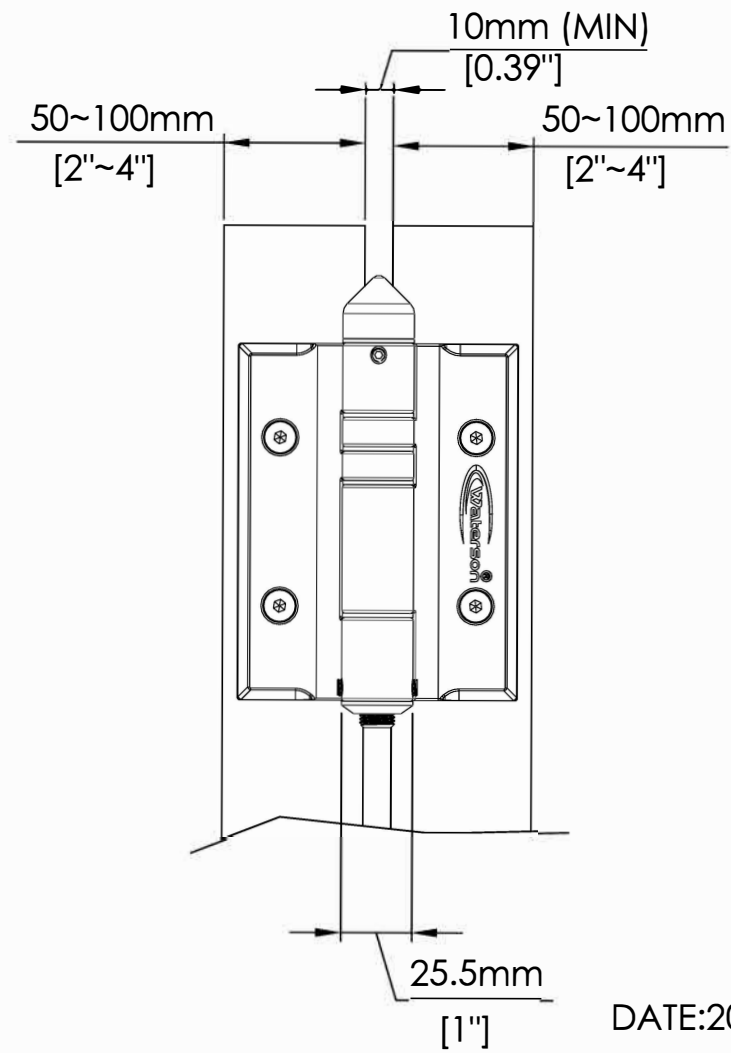

K51P

CLOSED (0°)

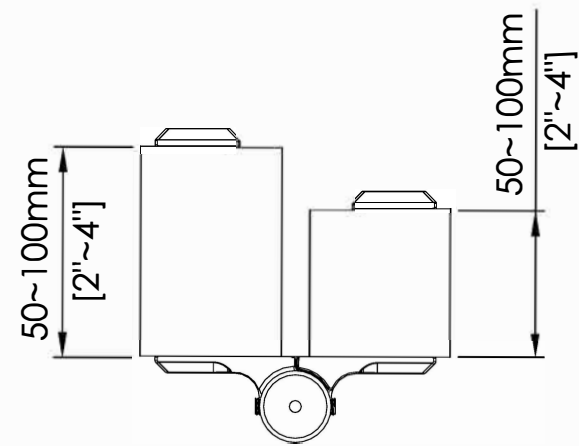
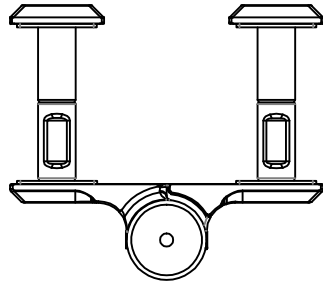

OPENING (90°)

